

FIG. 6

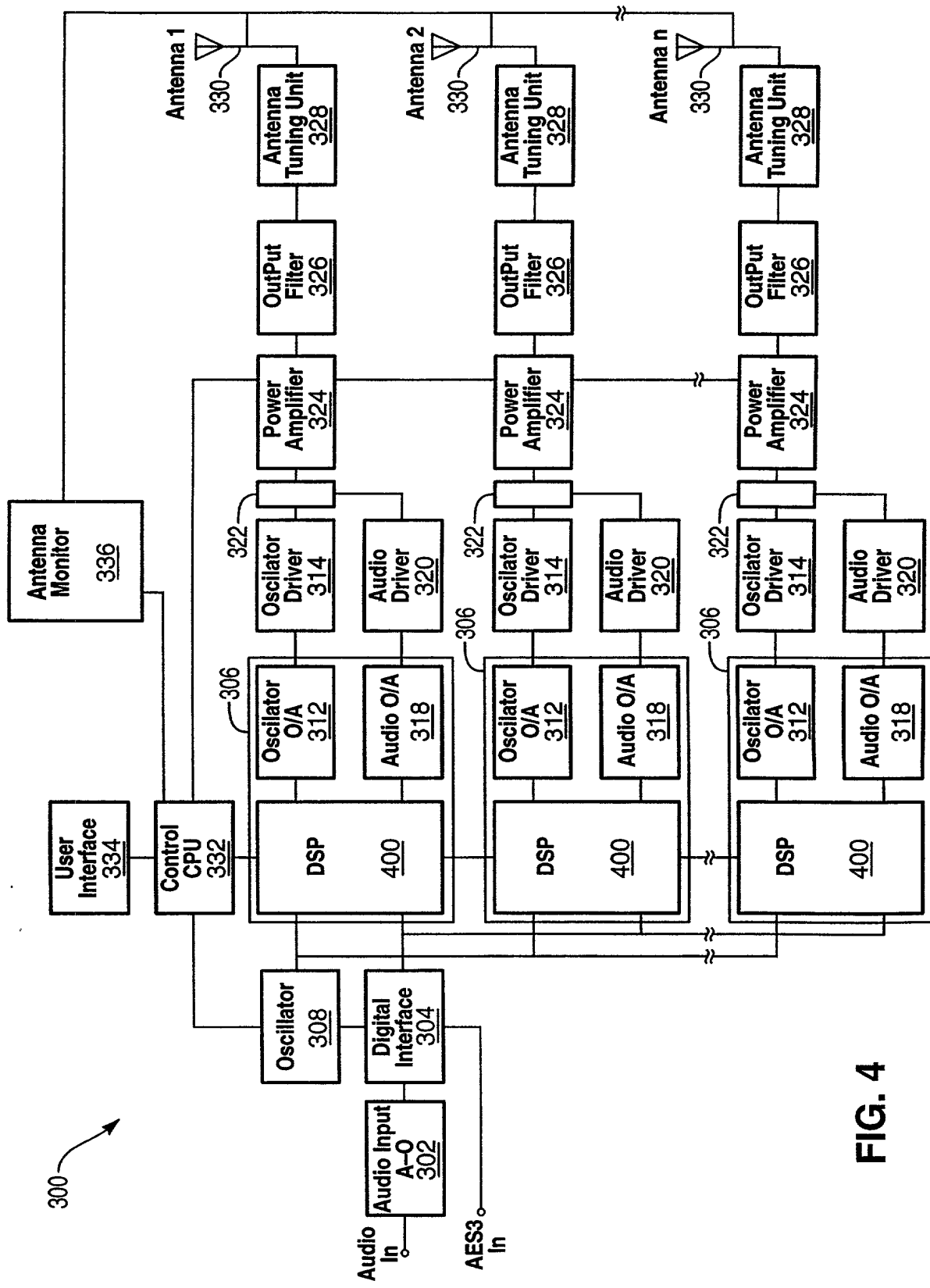

FIG. 4